

*Operator's Manual*



# Table of Contents

Table of Contents .....	2
Instrument Overview .....	3
Applications.....	5
Required Components (Stripped-and-Tinned Option).....	6
Required Components (Twist-Lock Option) .....	7
Controller Requirements and Connection .....	8
Stripped-and-Tinned Instruments: First Steps .....	9
With a PLC.....	9
With Comm Kit.....	9
Install the software .....	10
Connect the instrument to a computer .....	10
About Comm Kit .....	10
Data Tab .....	11
Communication Tab .....	12
Sensor Setup Tab .....	13
Probe Info Tab .....	14
Handheld Operation.....	15
Part Numbers .....	17
Getting Started .....	18
Navigating VuSitu .....	20
Calibrating Your RDO Instrument .....	22
Remote Setup .....	25
Instrument Specifications.....	27
Declaration of Similarity.....	30
Maintenance & Service .....	31
Warranty Information.....	33

# Instrument Overview

## Stripped-And-Tinned Option

Use the stripped-and-tinned RDO Blue in PLC-controlled monitoring systems.

1

### Stripped-And-Tinned Wires

Stripped-and-tinned wire allow you to connect the RDO Blue to a PLC or data logger.

2

### Probe Body

3

### Nose Guard/RDO Cap

The removable nose guard protects the RDO cap during deployment. The RDO cap is replaceable.



## ***Twist-Lock Option***

The twist-lock RDO Blue works with any Bluetooth-enabled mobile device and the VuSitu mobile app.



**1**

### ***Twist-Lock Connector***

The Twist-lock connector allows your RDO Blue to communicate with the VuSitu mobile. Just plug the connector into a Wireless TROLL Com and launch VuSitu.

**2**

### ***Probe Body***

**3**

### ***RDO Nose Guard and Cap***

The removable nose guard protects the RDO cap during deployment. The RDO cap is replaceable.

# Applications



The RDO Blue is ideal for dissolved oxygen measurement in a variety of situations.



***General Aquaculture***



***Inland Pond Aquaculture***



***Recirculating Aquaculture Systems***

## Required Components (Stripped-and-Tinned Option)



### Probe

Stripped-and-tinned wires are ideal for integration with a PLC and monitoring network.



### PLC

The RDO Blue communicates via the Modbus protocol.



### Comm Kit

Connect your RDO Blue to Comm Kit for calibration and programming. Attach the probe's stripped-and-tinned wires to the Comm Kit. Plug the Comm Kit into your PC's USB port.

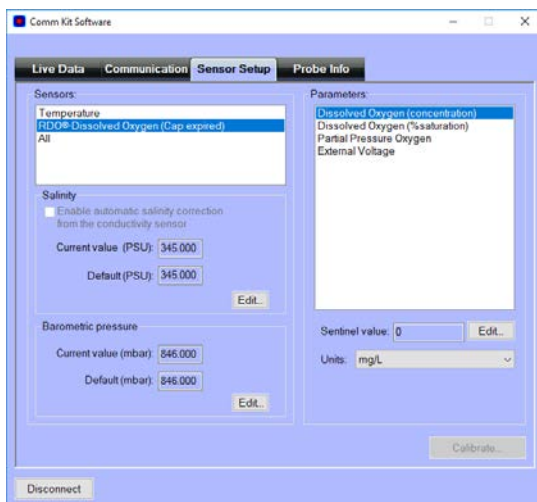

### Laptop with Comm Kit Software

Calibrate the RDO Blue and view live readings with Comm Kit software.

## Required Components (Twist-Lock Option)



You need these components to configure and deploy the RDO Blue.



### ***RDO Blue***

The RDO Blue's twist-lock connector attaches to a Wireless TROLL Com for communication with a Bluetooth-enabled mobile device.



### ***Wireless TROLL Com***

The Wireless TROLL Com enables communication between the instrument and your mobile device.



### ***Bluetooth-Enabled Mobile Device with VuSitu***

Install the VuSitu app on any Bluetooth-enabled mobile device. Calibrate, configure, and deploy the RDO Blue on Android or iOS.

# Controller Requirements and Connection

## Wiring Overview

Signal	Color
Ground/Return	Black
External Power	Red
RS485 (-)	Green
RS485 (+)	Blue



Keep the inside of the controller free of moisture and humidity. Condensed moisture can move through the wiring and cause the probe to fail. Install desiccant in the controller and replace it on a regular basis.

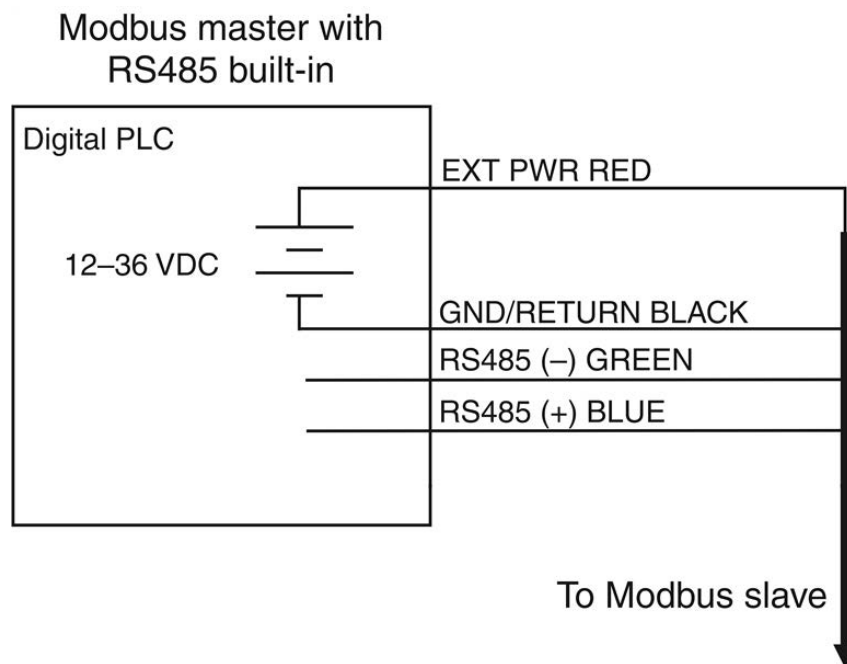



# Stripped-and-Tinned Instruments: First Steps



You can calibrate the RDO Blue and see live readings with In-Situ's Comm Kit software, available from [www.in-situ.com](http://www.in-situ.com).

## With a PLC



Connect the RDO Blue to your PLC.

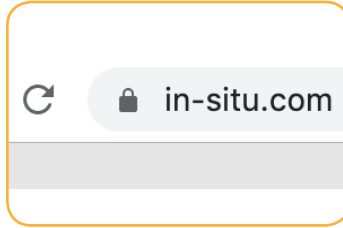

Download the RDO Blue Interface Spec from [www.in-situ.com](http://www.in-situ.com).



Refer to the Interface Spec for further instructions.

## With Comm Kit

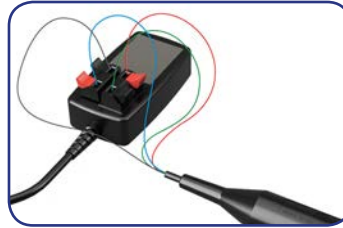

Connect the RDO Blue to the comm box.

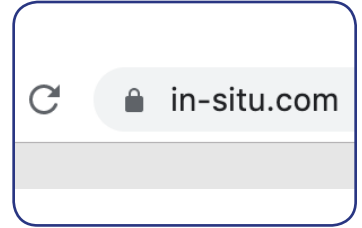

Download and install Comm Kit software from [www.in-situ.com](http://www.in-situ.com).

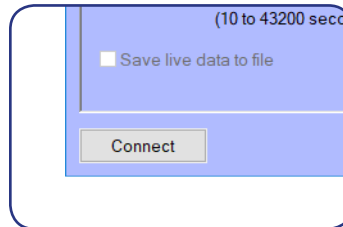

Launch the software and click **Calibration**.

## 1 Install the software.

## 2 Connect the instrument to a computer.



The communication device connects a stripped-and-tinned RDO or Aqua TROLL 400 to a computer via a USB port.



The communication device includes an electrical connection diagram label.

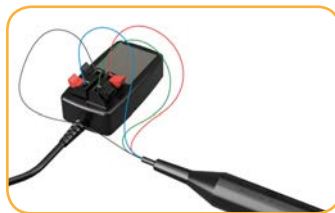

To attach the sensor to the communication device, depress a lever and insert the appropriate wire in the location specified by the diagram.

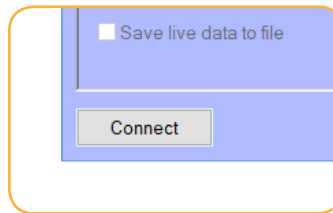

Wait for the computer to recognize the USB device, and then click the Connect button.

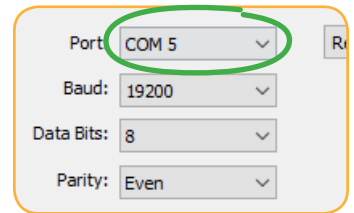

If the software does not connect to the software, you can find the COM port your computer has assigned in Windows Device Manager > Ports.

## About Comm Kit

Comm Kit software allows you to configure and calibrate your dissolved oxygen probe on a Windows PC.

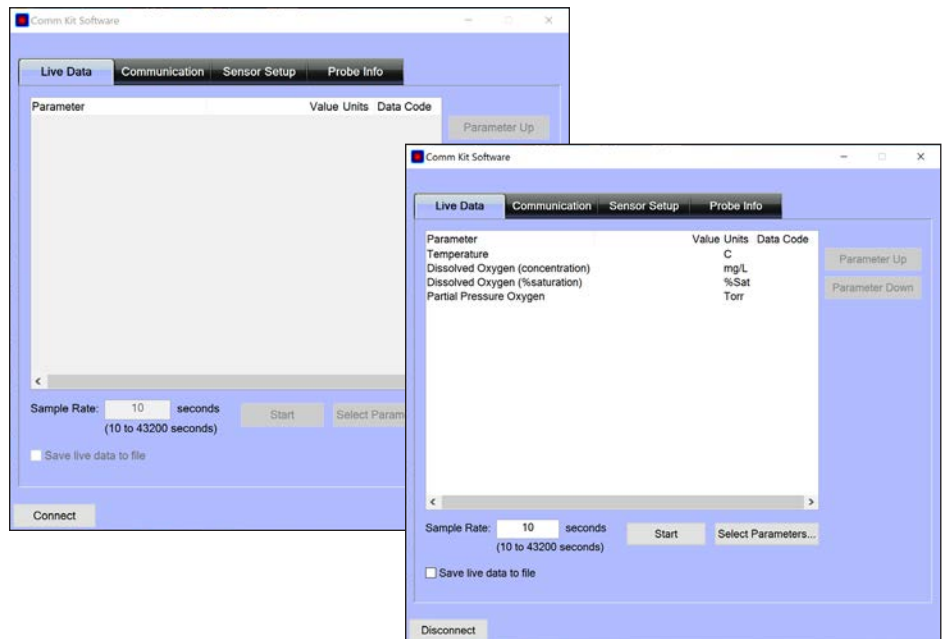

# Data Tab

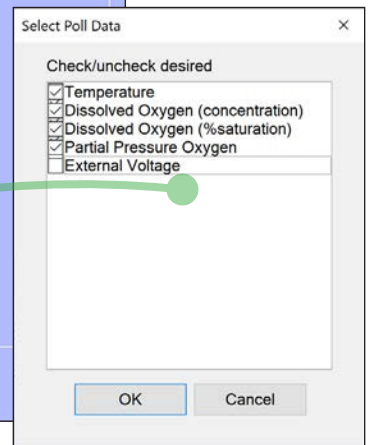
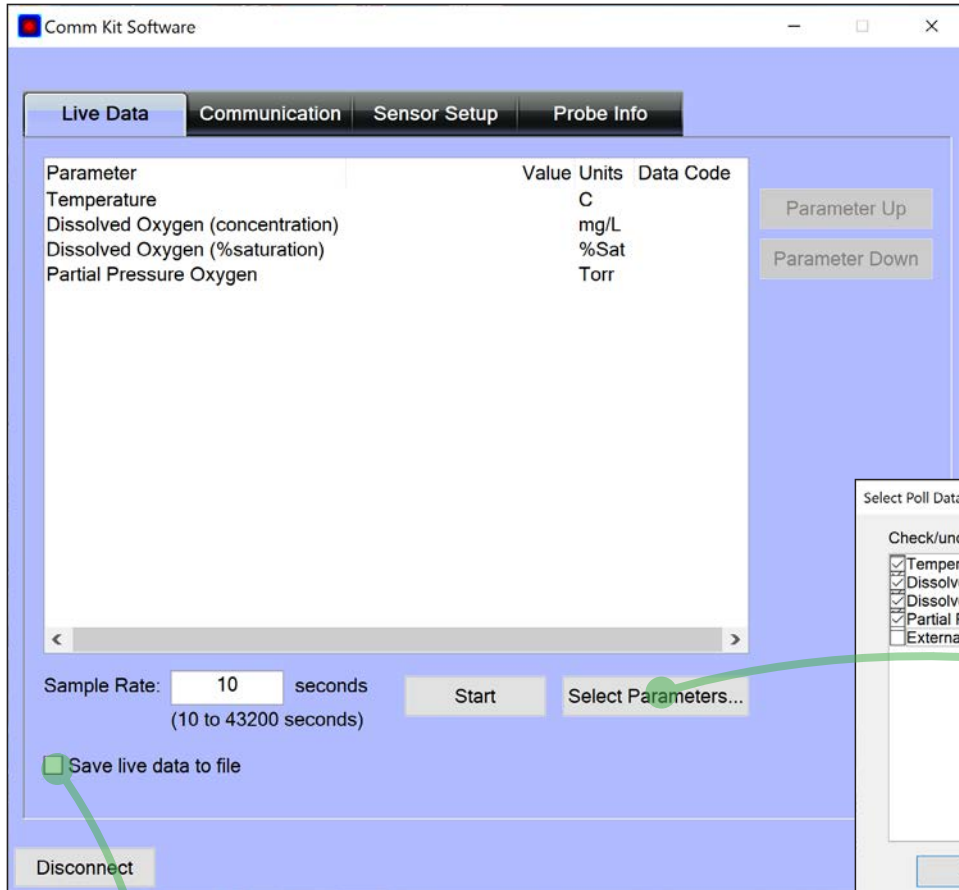

Choose the parameters Comm Kit saves to a data file with the **Select Parameters** button.

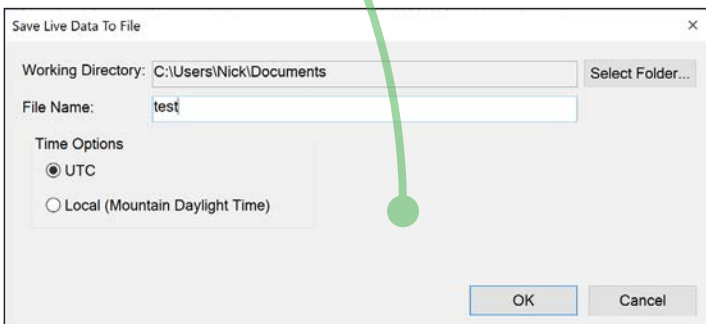

- 1 To save live readings to a spreadsheet, click the **Save live data to file** checkbox.
- 2 Click **Select Folder** and choose a destination for the file.
- 3 Name the file and press **OK**.
- 4 Enter a sample rate between 10 and 43200 seconds.
- 5 When you're ready to begin recording data, press the **Start** button.

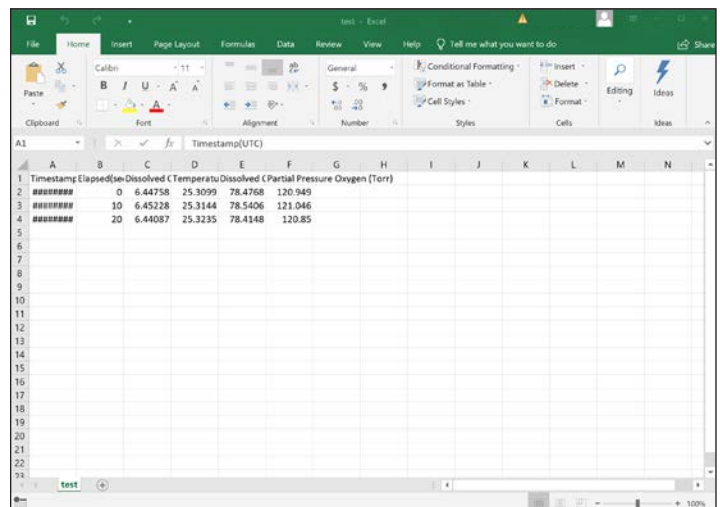

Comm Kit creates a spreadsheet file with one row for each reading.

# Communication Tab



Visit the Communication tab to change Modbus settings.

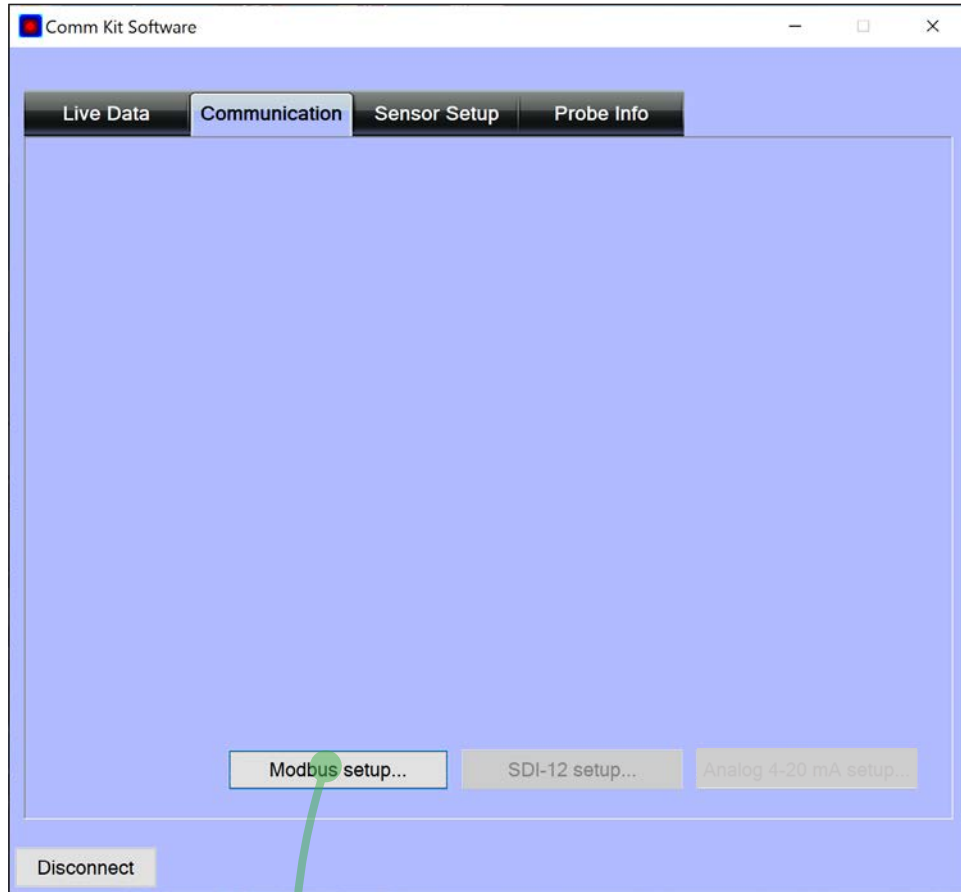

Probe Communication Settings

Baud: 19200	Modbus ASCII End of Message Timeout (ms): 1000
Data Bits: 8	EOM (1000 - 15000)
Parity: Even	Probe End of Session Timeout (ms): 5000
Stop Bits: 1	EOS (5000 - 60000)
Addr: 1	Measurement cache timeout (ms): 5000
Mode: Modbus RTU	(1000 - 60000)

OK Cancel

# Sensor Setup Tab

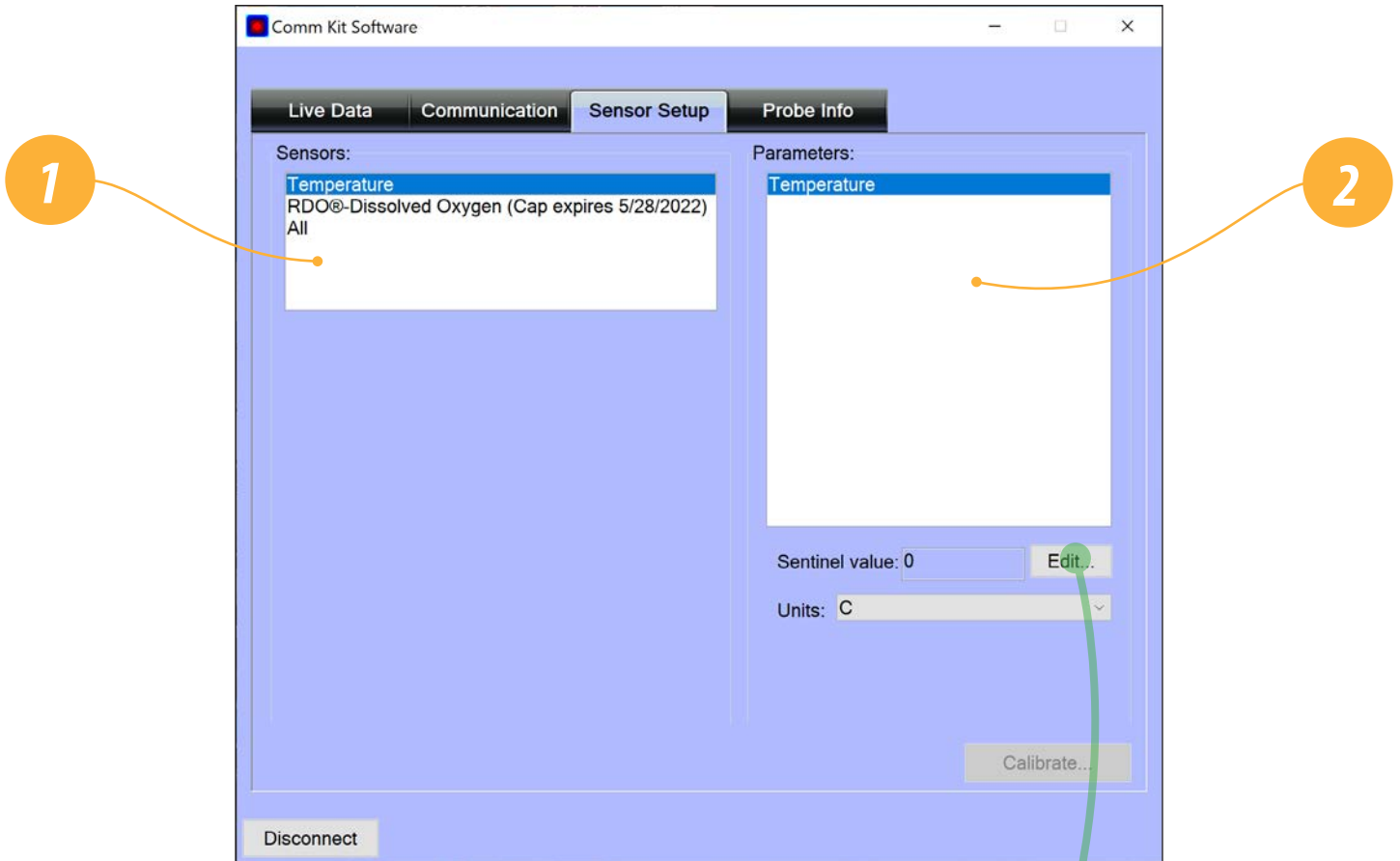

- 1 Use the tabs to navigate between functions.
- 2 Scroll through the parameters in the Live Data tab with the **Up** and **Down** buttons.

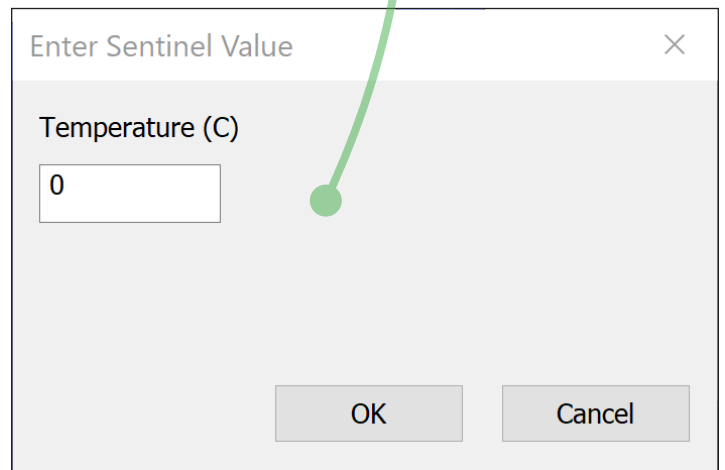

# Probe Info Tab

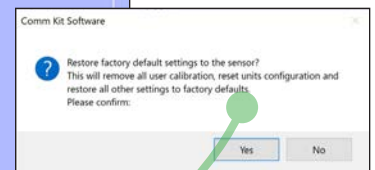
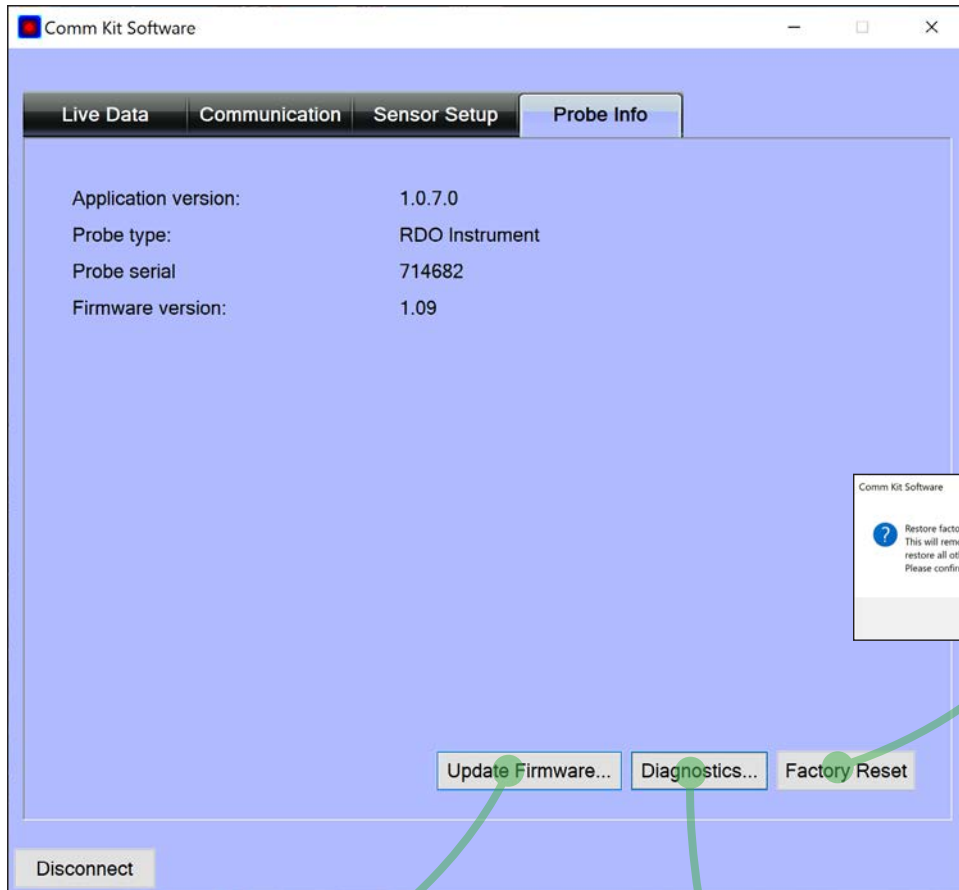

Comm Kit will ask for confirmation before resetting.

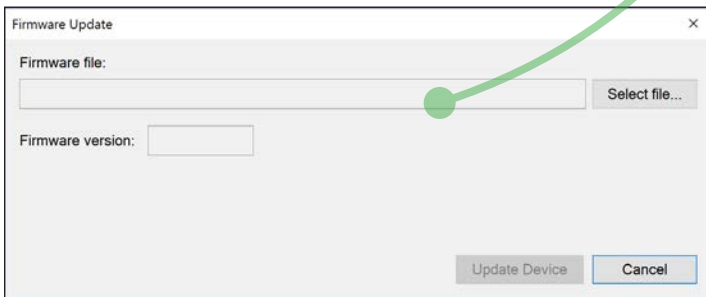

- 1 Click **Update Firmware** to install the latest firmware.
- 2 Then click **Select file** and choose your firmware.
- 3 The version number will appear in the Firmware version box.

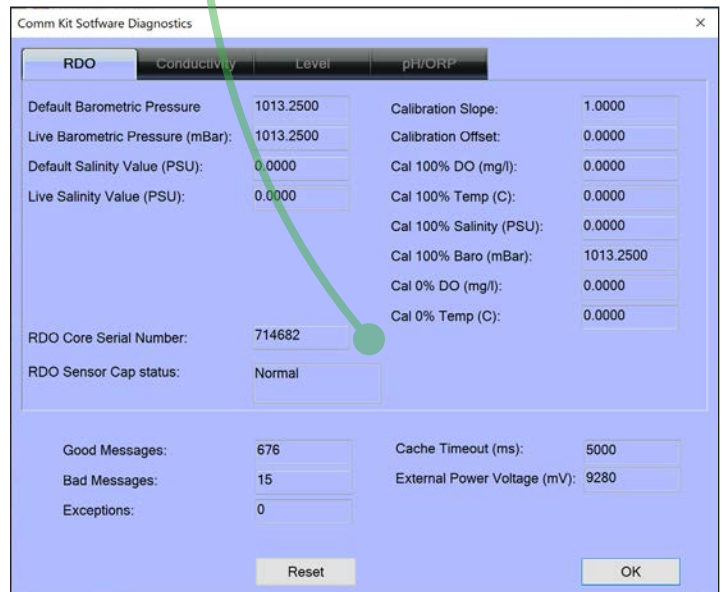

The diagnostics tabs display critical sensor, sensor cap, calibration, and power supply info.

# Handheld Operation



To configure and deploy the RDO Blue, use a Wireless TROLL Com and a Bluetooth-enabled mobile device with the VuSitu app.





Set up and deploy your RDO instrument in four simple steps. Read the overview below, and then see the following pages for detailed instructions.



Install the RDO cap and attach the instrument to a Wireless Rugged TROLL Com.



Use the VuSitu mobile app to pair your Wireless TROLL Com with your mobile device.

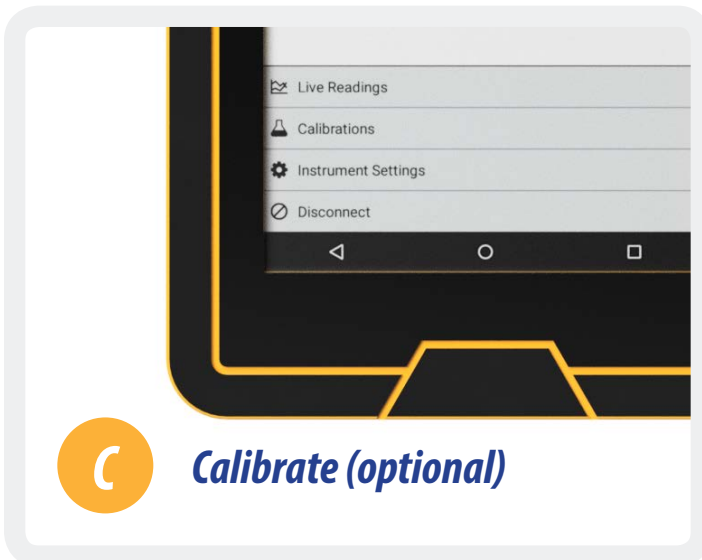

The RDO Blue is factory calibrated, but you can perform a calibration at any time with VuSitu. Select **Calibrations** from VuSitu's menu. Follow the on-screen instructions.



Select **Live Readings** to view real-time readings from the instrument.



## Part Numbers



### **Kit #0103190**

- 1 RDO Blue with **10 meter** cable
- 2 Wireless TROLL Com
- 3 Lanyard for Wireless TROLL Com

### **Kit #0103210**

- 1 RDO Blue with **3 meter** cable
- 2 Wireless TROLL Com
- 3 Lanyard for Wireless TROLL Com



### **#0038640**

- RDO Blue with **10 meter** cable

### **#0103200**

- RDO Blue with **3 meter** cable



The Wireless TROLL Com's lanyard is not a weight-bearing part.

# Getting Started

## 1 Install the RDO cap.



Align the RDO cap so the flat edge on the inside matches up with the flat edge on the sensor. Slide the RDO cap into place.



Slide the nose guard into place and thread it clockwise to install.

## 2 Connect the instrument to a Wireless TROLL Com.

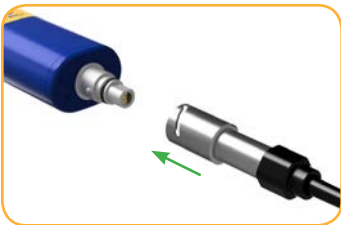

Attach the RDO Blue's twist-lock connector to the end of the Wireless TROLL Com.



Make sure the flat edges of the connectors align, and then push and twist.



You will hear a click when the cable is connected properly.



Press the power button on the Wireless TROLL Com.

### 3 Pair the Wireless TROLL Com with your mobile device.



You must have the VuSitu mobile app to use the RDO Blue with a mobile device. Download VuSitu from the Google Play Store or the Apple App Store.

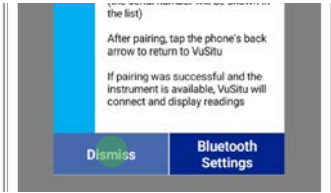

Make sure your mobile device's Bluetooth is turned on. Launch VuSitu and tap **Dismiss**.

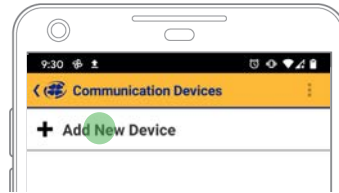

Tap **Add New Device** and select the Wireless TROLL Com from the list of available devices.

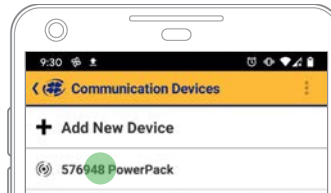

Tap your mobile device's back button. In VuSitu, tap the serial number of your Wireless TROLL Com.

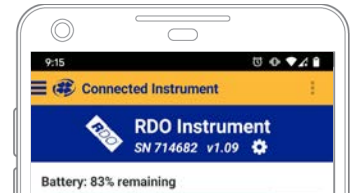

VuSitu displays the Connected Instrument screen when pairing is complete.

### 4 Configure and deploy the RDO Blue.



VuSitu will guide you through configuration, calibration, and other tasks. Choose an option from the menu to get started.

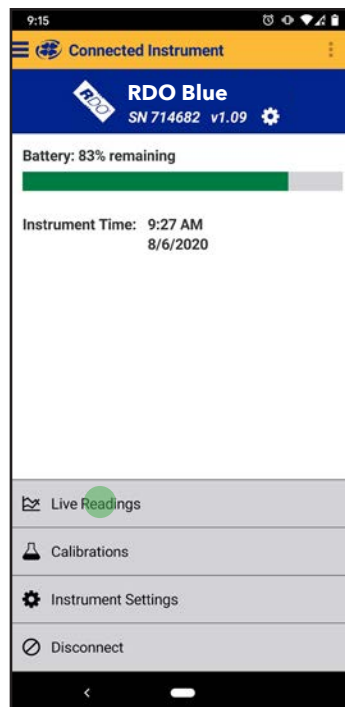

# Navigating VuSitu



After Bluetooth pairing, VuSitu displays the Connected Instrument screen. You can access all features of the app from this screen.

## Connected Instrument Screen

The screenshot shows the 'Connected Instrument' screen for an 'RDO Blue' device. The top status bar shows the time as 9:15 and various system icons. The app header is orange with a menu icon on the left and a help icon on the right. Below the header is a blue section with the RDO logo, the device name 'RDO Blue', its serial number 'SN 714682', version 'v1.09', and a settings gear icon. The main content area displays 'Battery: 83% remaining' with a green progress bar, and 'Instrument Time: 9:27 AM 8/6/2020'. At the bottom, there is a list of menu items: 'Live Readings', 'Calibrations', 'Instrument Settings', and 'Disconnect'. Callout boxes provide instructions for each of these elements.

Access menu.

Access help information.

Battery: 83% remaining

Instrument Time: 9:27 AM  
8/6/2020

Take single readings or continuously record at two-second intervals.

Calibrate sensors.

Access instrument clock and telemetry settings.

Disconnect app from instrument.

## Selecting With Long-Press And Swipe

### Long-press

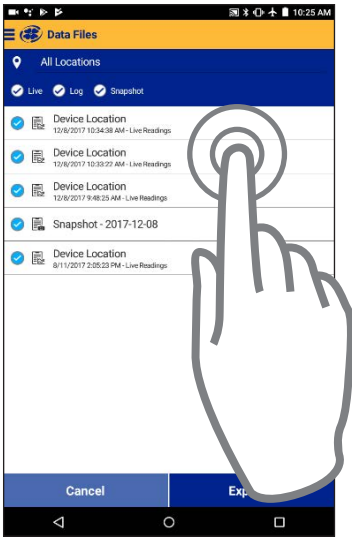

Press and hold any of the items in a list of files.

You can now select two or more items.

### Swipe left

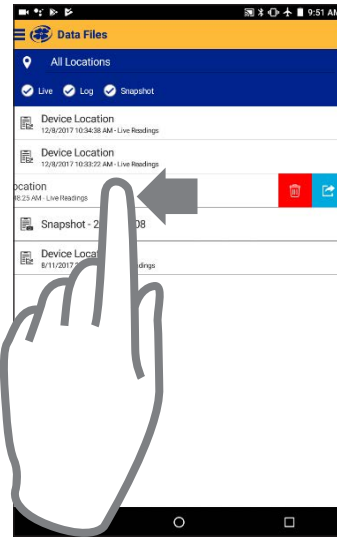

Press an item and swipe left to reveal the delete and sharing icons.

### Swipe right

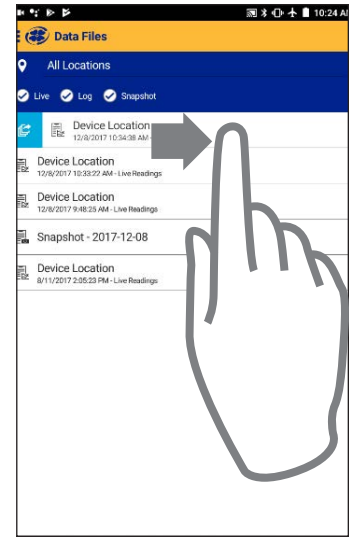

Press any item in a list and swipe right to reveal the sharing icon.

# Calibrating Your RDO Instrument



VuSitu guides you through calibrations. To get started, use the app to choose a calibration type as shown below.

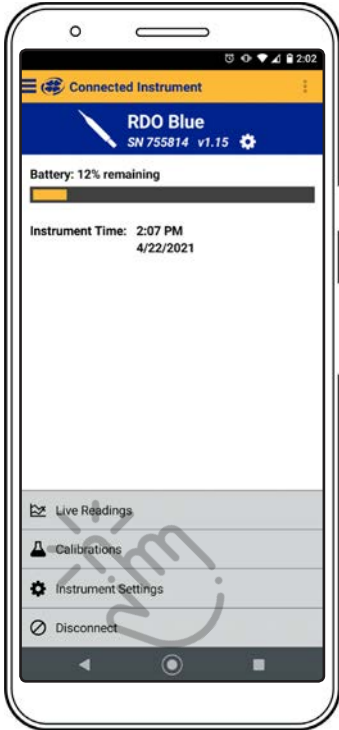

Select **Calibrations** from the menu.



Choose the type of calibration you wish to do.

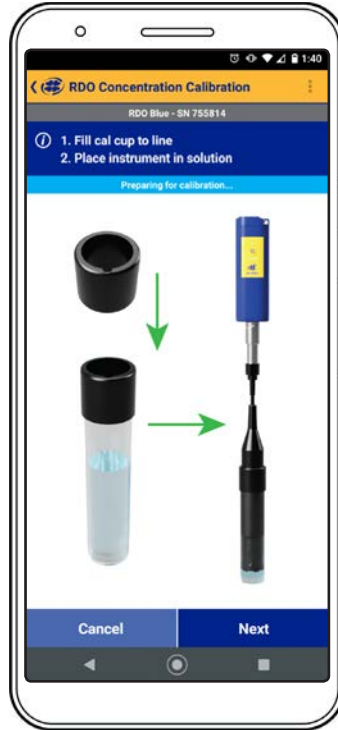

Follow the instructions in VuSitu.

## One-Point Calibration

### Water-Saturated Air Calibration



**Vented cap**

Remove the storage cap from the top of the calibration chamber and replace it with the vented cap.



Saturate the sponge wafer (use approximately 10 mL of water) and place it in the bottom of the calibration chamber.

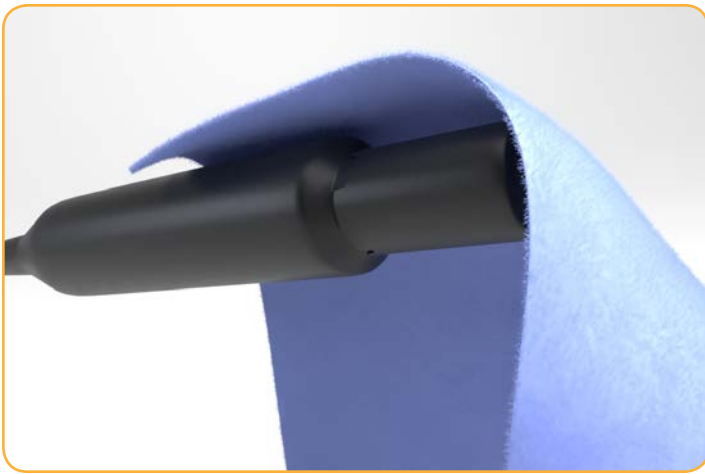

Gently dry the probe and sensing element with a paper towel.



Place the probe in the calibration chamber so that the sensing element is about 2.5 cm (1 inch) above the water-saturated sponge.



Be sure the sensor surface is dry when you place the probe into the calibration chamber.

### ***Two-Point Calibration***



Remove the water-saturated sponge from the calibration chamber. Fill the chamber to the fill line with approximately 60 mL of fresh sodium sulfite.



## Concentration-Based Calibration

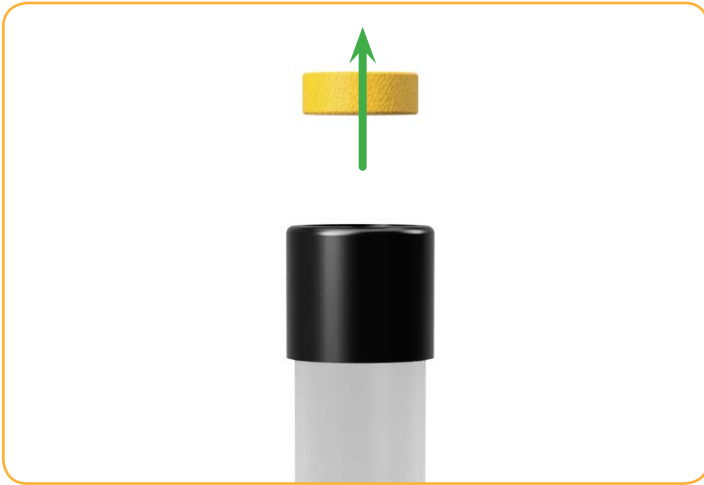

Remove the sponge from the calibration cup



Fill the cup to the fill line with approximately 60 mL of fresh solution.



Place the probe into the solution. Leave at least 13 mm (0.5") between the surface of the sensing element and the bottom of the calibration cup.



## Remote Setup



1

### **Carabiner**

The carabiner allows a VuLink to attach to the top of a well via a well dock.

2

### **VuLink telemetry device**

VuLink powers the RDO Blue and transmits data to HydroVu or another FTP server.

3

### **RDO Blue**

## 1 Create a HydroVu account.

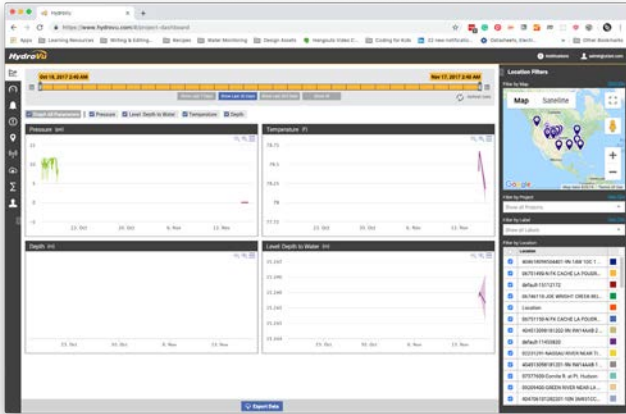

Visit [hydrovu.com](https://hydrovu.com) and create an account.

## 2 Go to the telemetry page.

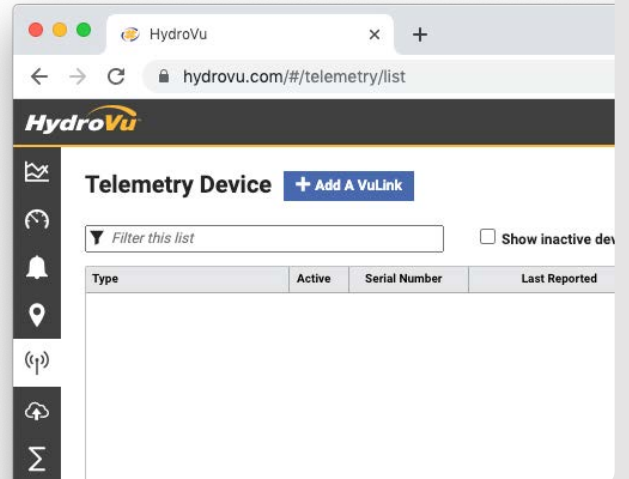

Click the telemetry page link in the menu on the left side of the page. Then click **Add a VuLink**.

## 3 Scan the QR code on your VuLink.



or



Open your web camera and scan the QR code on your device, or type the registration code into the provided field.

## 4 Attach the antenna and connect an instrument.



After connecting the antenna and instrument, follow the instructions on the next pages of this quickstart guide.

# Instrument Specifications

## Sensor Ratings

Sensor Type	Optical Dissolved Oxygen Sensor
Range, DO	0-60 mg/L; 0-600% Saturation
Accuracy, DO	+/- 0.1 mg/L (0-20 mg/L) +/-2% (20-60 mg/L)
Resolution, DO	0.01 mg/L
Response Time, Cap	T63<5s, T90<45s, T95<60s (RDO-X cap)
Units, DO	mg/L, ppm, % saturation
Range, Temp.	-5°C to 50°C (23°F to 122°F)
Accuracy, Temp.	+/- 0.1°C
Resolution, Temp.	0.01°C
Units, Temp.	Celsius, Fahrenheit
Salinity Comp.	Fixed or real-time capable
Barometric Comp.	Fixed or real-time capable
Methods	EPA-approved In-Situ® RDO methods 1002-8-2009, 1003-8-2009, 1004-8-2009 Standard Methods 4500-O

## Environmental Ratings

Pressure	150 psi from 0° to 50°C
Depth	100m (328ft) @ 25°C
Operating Temp. (Non-Freezing)	-5.0°C to + 50.0°C (23°F to 122°F)
Storage Temp.	-40°C to + 65°C (-40°F to 149°F)
Compliance	EMC 2014/30/EU IEC 61000-6-2:2005 EN 55011:2009
Ip Rating	IP-67 with sensor cap off; IP-68 with sensor cap installed

## Chemical Ratings

INTERFERENCES	Alcohols >5%; hydrogen peroxide > 3%; sodium hypochlorite (commercial bleach) > 3%; gaseous sulfur dioxide; gaseous chlorine. Do not use in organic solvents (e.g., acetone, chloroform, methylene chloride, etc.), which may swell the sensing element (foil matrix) and destroy it.
---------------	---

## General Ratings

Dimensions	L 22.06 cm (8.69 in) x D 2.95 cm (1.16 in)
Weight	205 g (0.5 lb) (without cable)
Wetted Materials	Ryton® (PPS), Cycloy® (PC/ABS), PC/PMMA
Communication Output	Modbus/RS485
Reading Rate	1 reading every 1 second
Power Requirements	8 to 36 VDC
Power Consumption	Maximum (measurement): 50 mA at 12 VDC Idle (communication only): 2 mA at 12 VDC
Warranty	2 years from date of shipment

NOTES: Ryton is a registered trademark of Solvay SA.; Cycloy is a registered trademark of SABIC GLOBAL Technologies B.V.

REV	CR#	CR NOTES	REVISED BY	DATE
001	-	INITIAL RELEASE	JMC	3/26/2021

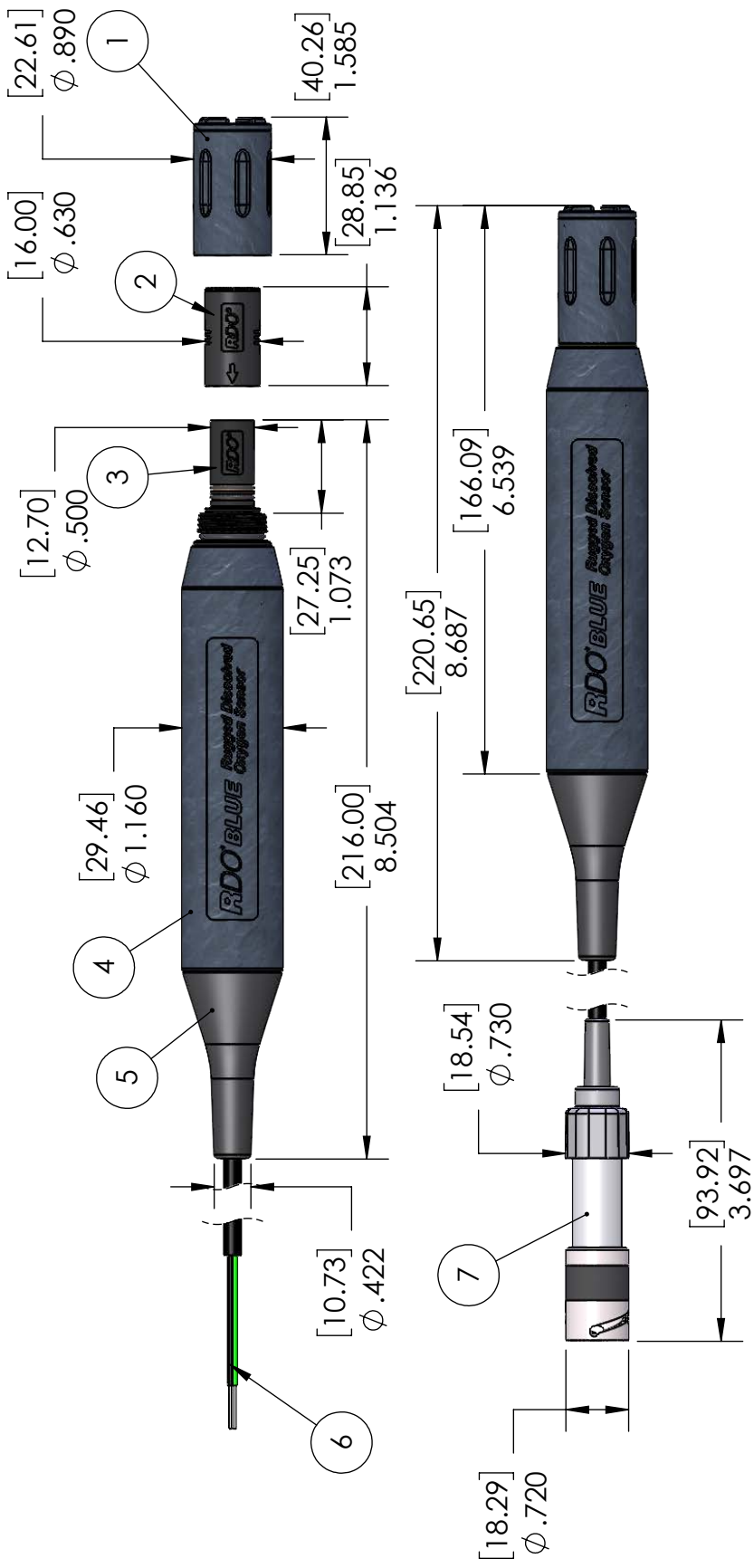

PART NAMES	
NUMBER	DESCRIPTION
1	STANDARD GUARD
2	RDO SENSOR CAP
3	SENSOR NOSE
4	MAIN HOUSING
5	CABLE STRAIN RELIEF
6	STRIPPED AND TINNED WIRES
7	TWIST-LOCK CONNECTOR

CONDUCTORS	
COLOR	SIGNAL
BLACK	GROUND/RETURN
RED	EXTERNAL POWER
GREEN	RS485(-)
BLUE	RES485(+)

SILVER IS SHIELDED WIRE FOR CHASSIS OR EARTH GROUND



PROPERTY OF IN-SITU INC.  
 NO REPRODUCTION WITHOUT WRITTEN PERMISSION  
 221 E. LINCOLN AVE, FORT COLLINS, CO. 80524  
 PH 970-498-1500 FAX: 970-498-1519

DESCRIPTION: RDO BLUE PUBLISHED DIMENSIONS		DRAWN BY/DATE
MATERIAL: SEE TABLE ABOVE		JMC-3/26/2021
SHT #	TOLERANCES	APPROVED BY/DATE
1 OF 1	X* ± 1* X ± .02 [0.5]	EB-3/29/2021
SCALE	SIZE	PART NUMBER
1:2	.XX ± .01 [0.2]	0096360
FINISH: N/A	.XXX ± .005 [0.1]	
WETTED MATERIAL		TITANIUM



## Declaration of Similarity

Manufacturer: In-Situ, Inc.  
221 East Lincoln Avenue  
Fort Collins, CO 80524  
USA

Declares that the performance of the following product is equivalent to the **RDO® Core Analog Dissolved Oxygen Sensor Module**

**Product name:** RDO® Blue  
**Model:** RDO® Blue Twist-Lock Termination, Stripped/Tinned Termination  
**Product Description:** Optical Dissolved Oxygen and Temperature Measurement Probe

is in compliance with the following Directives

- Electromagnetic Compatibility (EMC) Directive, 2014/30/EU
- Restriction of the use of certain hazardous substances in electrical and electronic equipment (RoHS) Directive, 2011/65/EU and Commission Delegated Directive, (EU) 2015/863

and meets or exceeds the following international requirements and compliance standards:

- **Immunity**  
IEC 61000-6-2:2016 (EN 61000-6-2, KN 61000-6-2)  
Electromagnetic compatibility (EMC) - Part 6-2: Generic standards - Immunity for industrial environments
- **Emissions**  
EN 55011:2009 + A1:2010, KN32: 2015-12, FCC Part 15 Subpart B  
Radio disturbance characteristics for scientific and medical equipment

The CE mark is affixed accordingly.

Ben Kimbell  
VP of R&D  
In-Situ, Inc.  
October 28, 2020



## Maintenance & Service

### Cleaning the Sensor Cap



Keep the cap on the probe during cleaning.



Rinse the sensor with clean water from a squirt bottle or spray bottle.



Gently wipe with a soft-bristled brush or soft cloth to remove bio-fouling.



To remove extensive mineral build-up, soak the probe cap-down in vinegar for 15 minutes. Then soak in deionized water for 15 minutes.



Do not use organic solvents to clean the sensor or probe; they will damage the sensing element.

### Cleaning the Optical Window



Clean the optical window only when you change the cap.

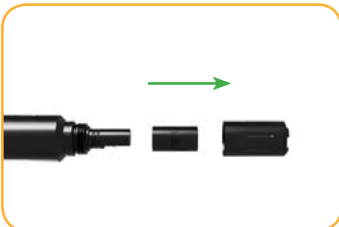

Remove the cap and gently wipe the lens with the supplied lens cloth.



Do not use water or any kind of solution to clean the optical window.

## Cleaning the Probe

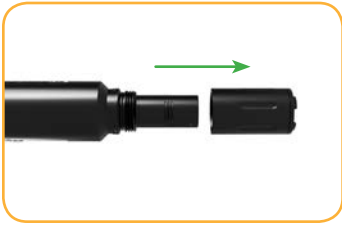

Remove the nose guard.



Use a lint-free cloth to dry the probe.



Pull the used RDO cap off of the sensor, without twisting.



Remove the existing O-rings from the sensor.



Use your finger to apply a light layer of silicone-based lubricant around the O-ring grooves.



Place the O-rings on the sensor. Apply another thin layer of lubricant to the O-rings and grooves.



Align the flat edge inside the RDO cap with the flat edge and metal contacts on the probe. Slide the cap in place.



Thread the nose guard onto the probe.



## *Warranty Information*

In-Situ provides a 2-year, limited warranty on the RDO Blue instrument. To make a return, visit [www.in-situ.com](http://www.in-situ.com) and fill out a return material authorization (RMA) form.